

12. 6 CONTROL AMPLIFIER ASSEMBLY (AWG-027-0)

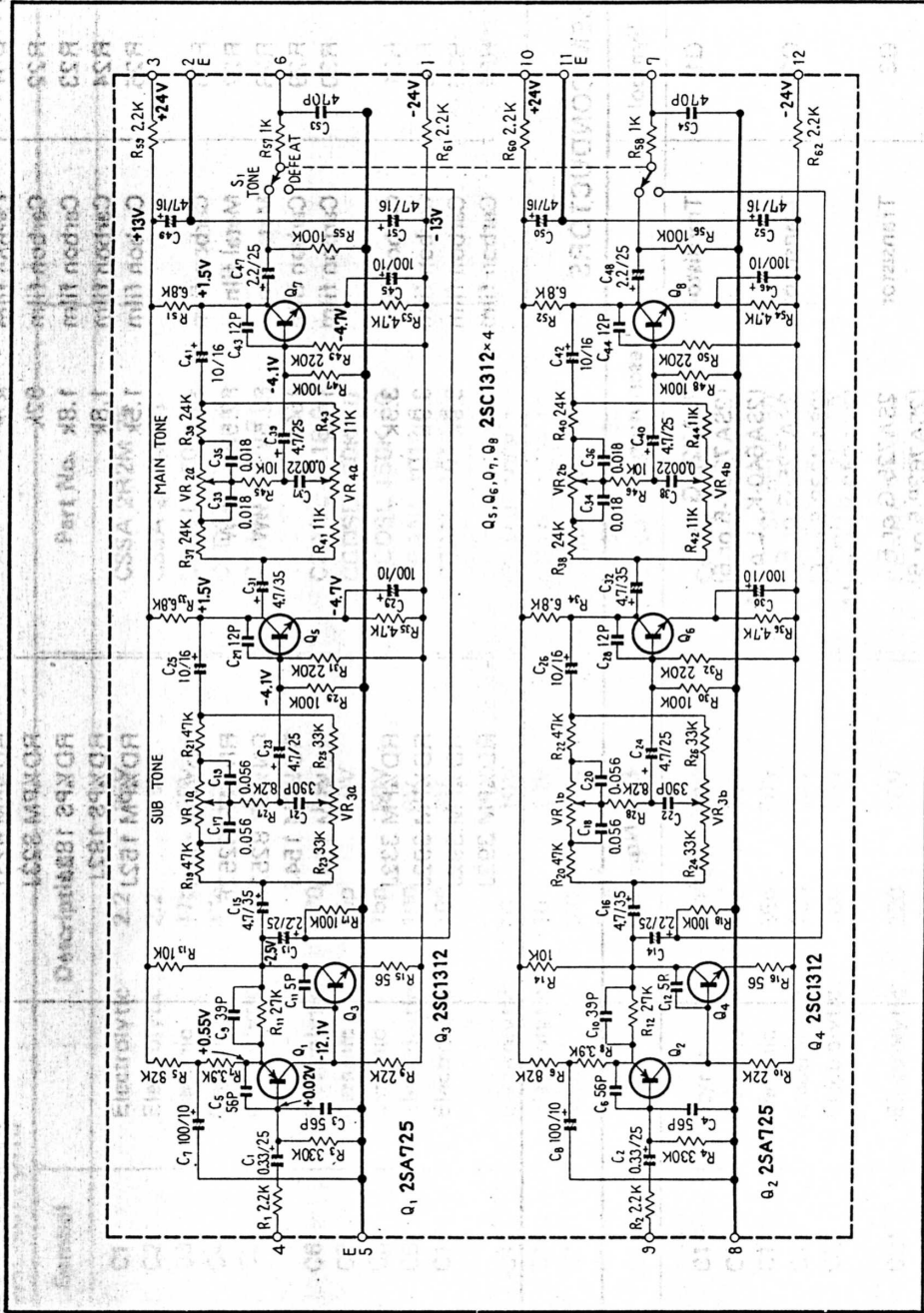

Foil Side

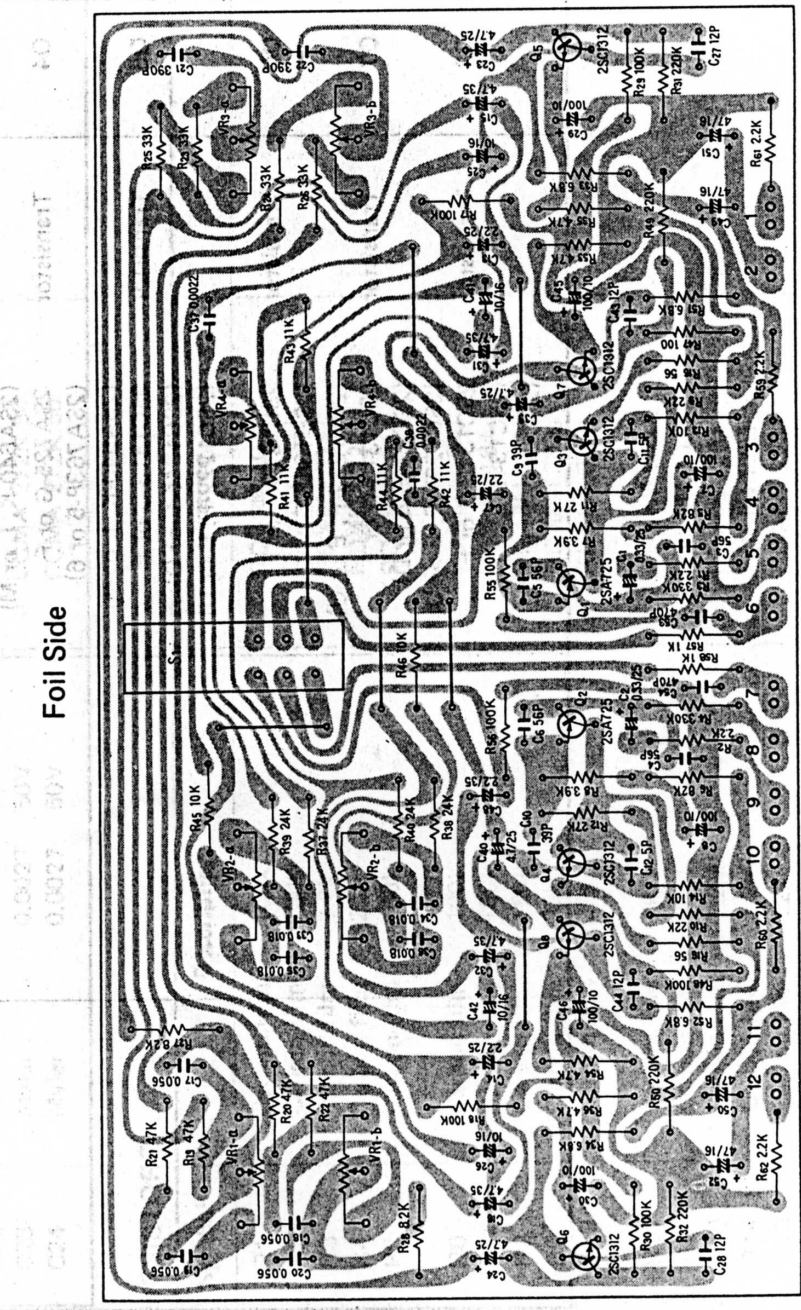
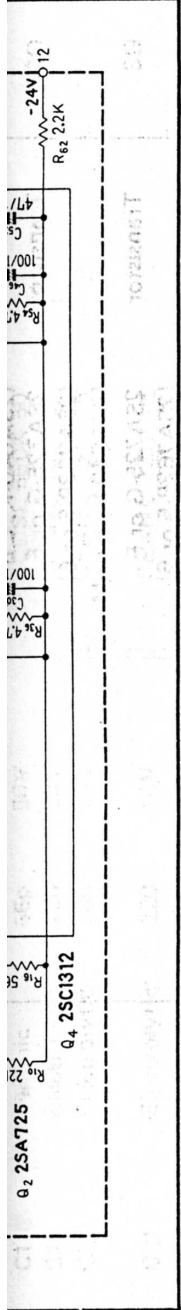

Foil Side

2SA725
2SC1312



SX-1010

12.7 POWER AMPLIFIER ASSEMBLY (AWH-032-0)

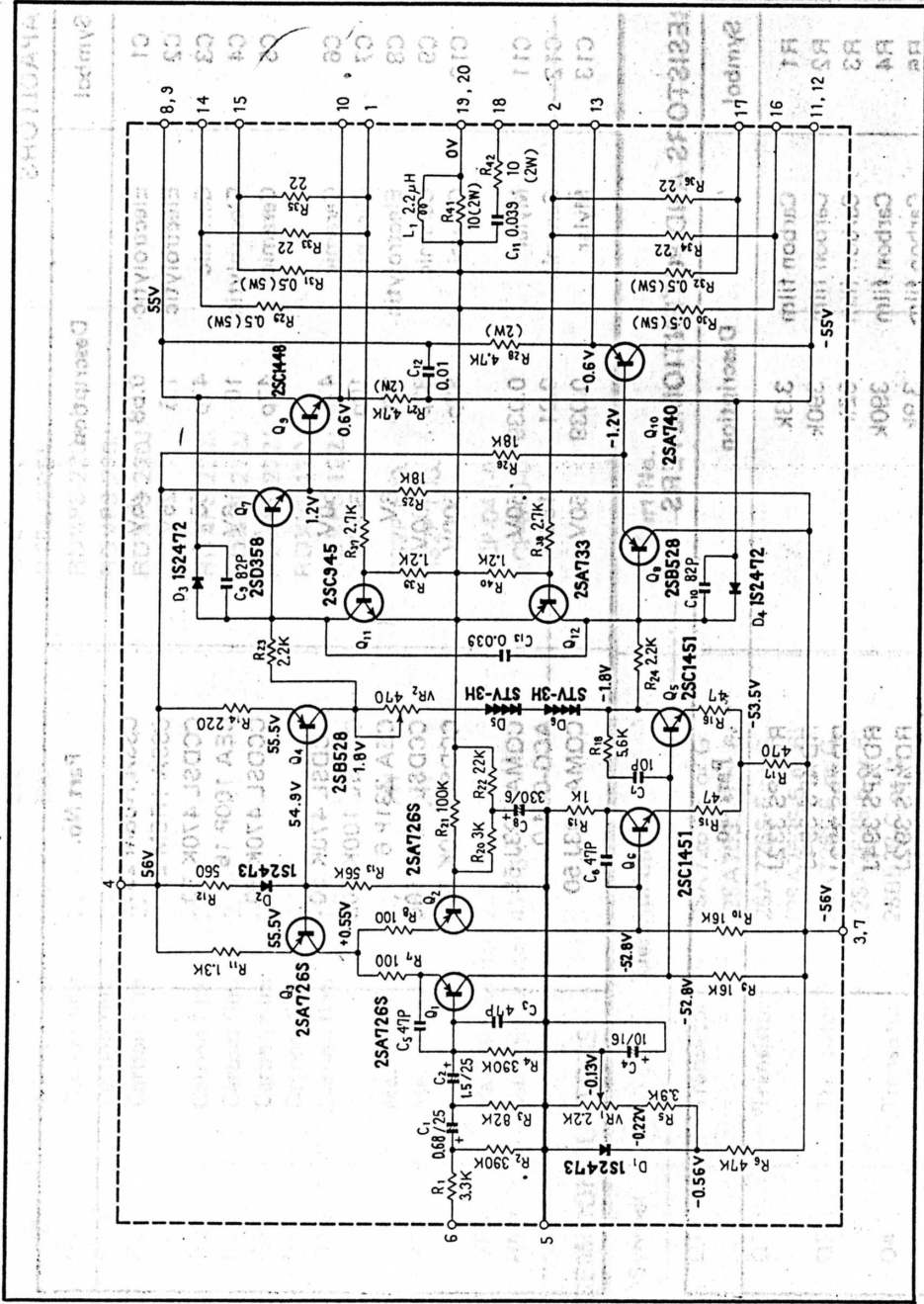

Foil Side

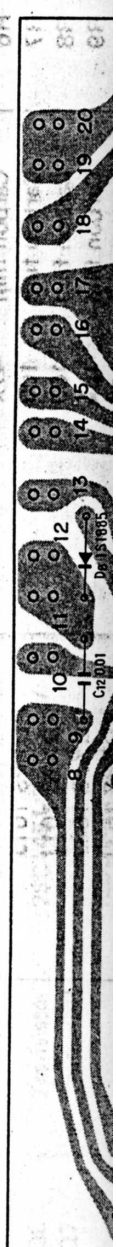

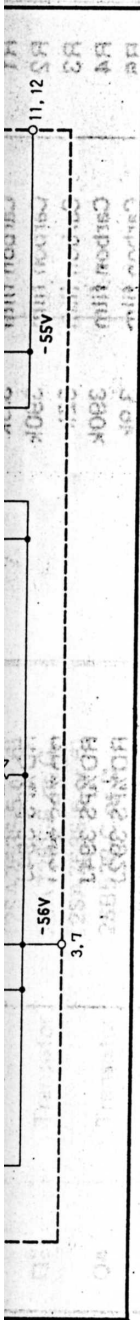

Foil Side

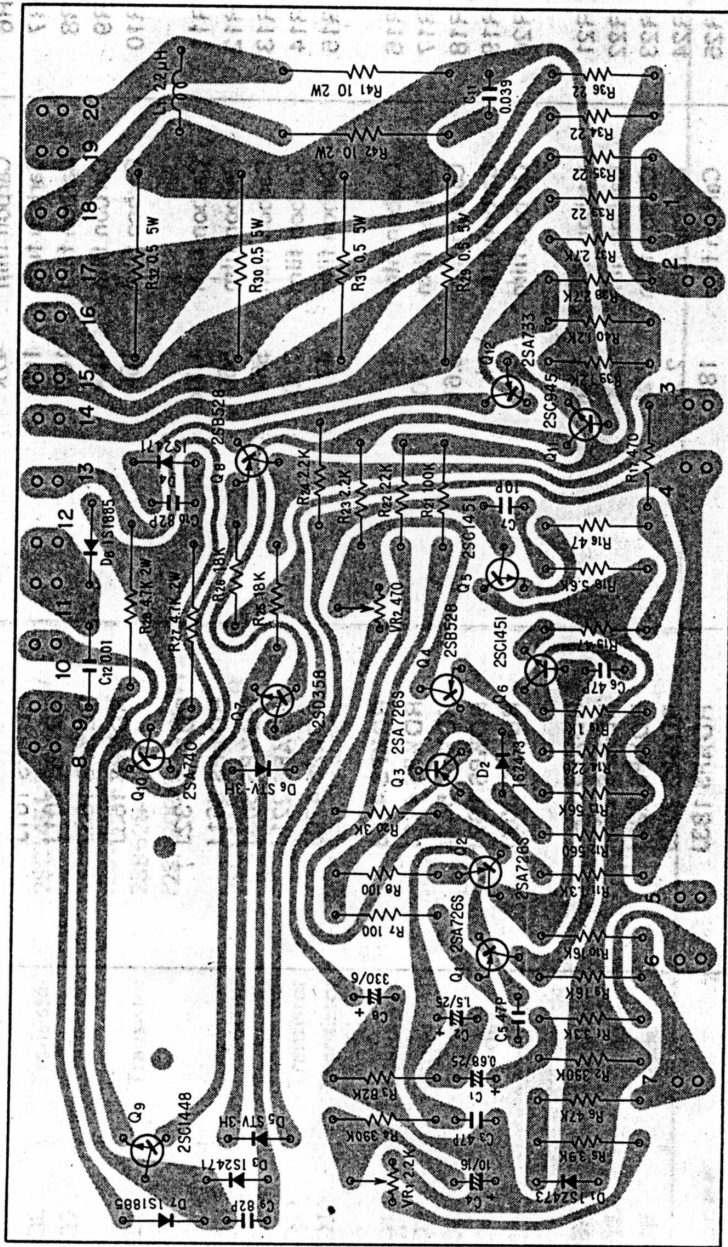

	2SA726S		2SB528		2SD358		2SC1451
	2SA733		2SC945		2SA740		2SC1448
	2SC945		2SA740		2SC1448		2SC1448

0101-302

12. 8 PROTECTION CIRCUIT ASSEMBLY (AWM-062-0)

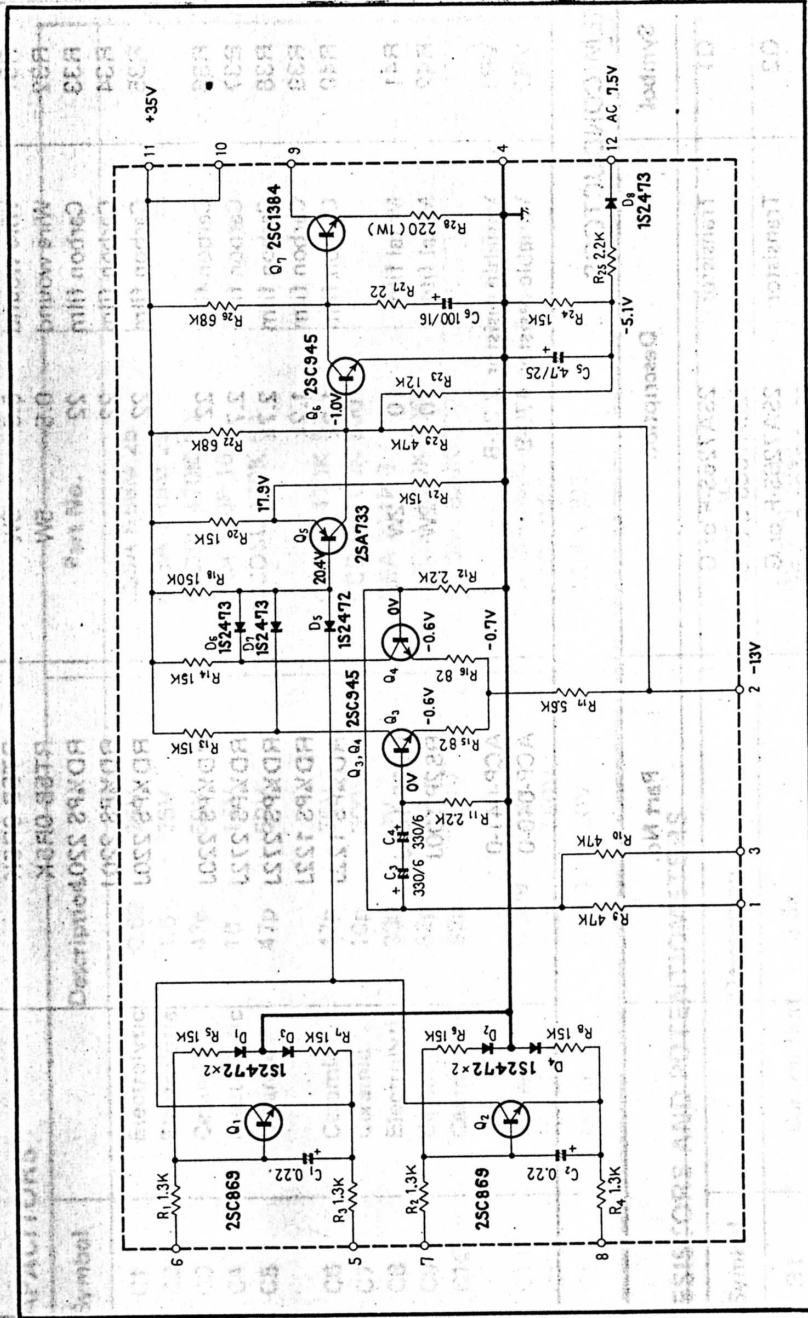

Foil Side



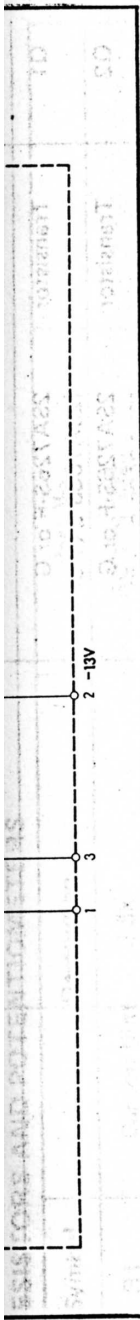

Foil Side

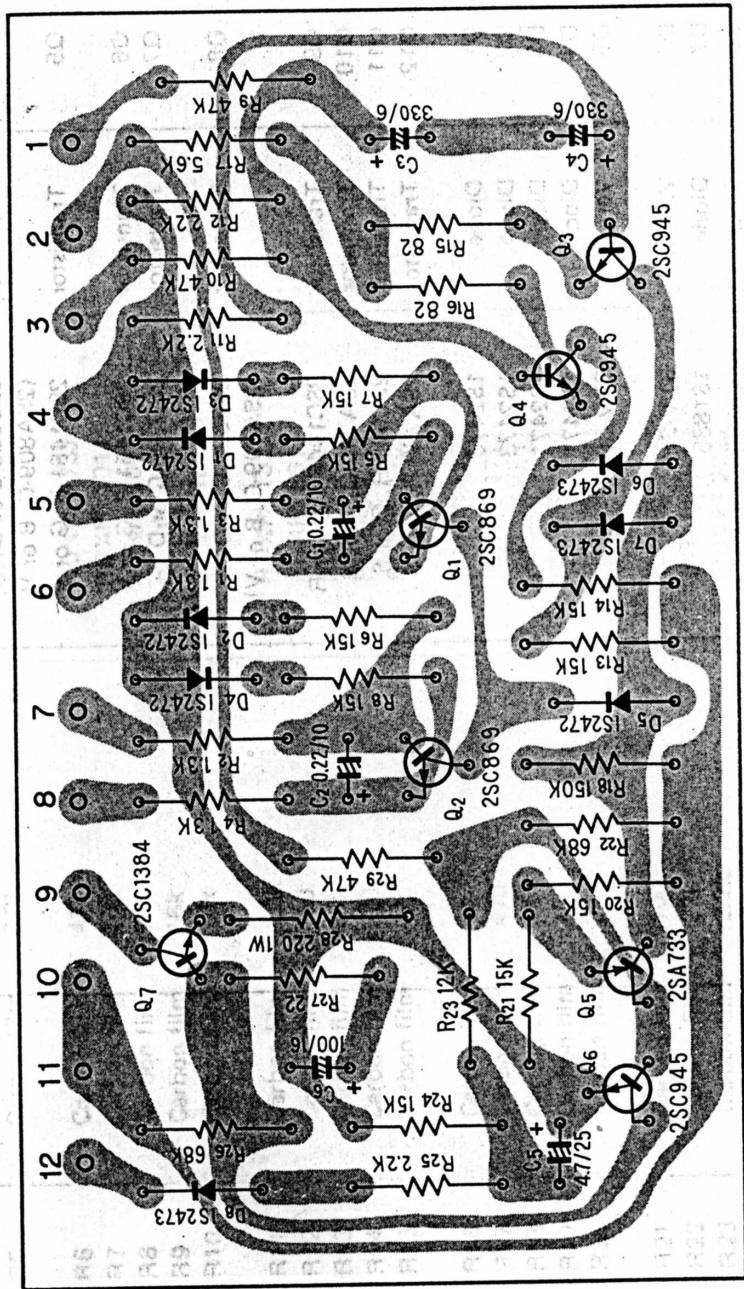

2SC869

2SA733

2SC945

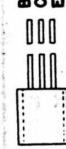
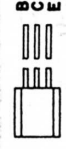
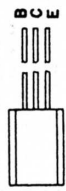

SX-1010

12.10 POWER SUPPLY CIRCUIT ASSEMBY (AWR-054-A)

- 2SD313P
- 2SD313
- 2SB507P

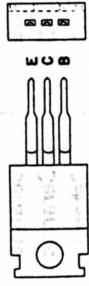

2SC869



2SC1384



2SA628A

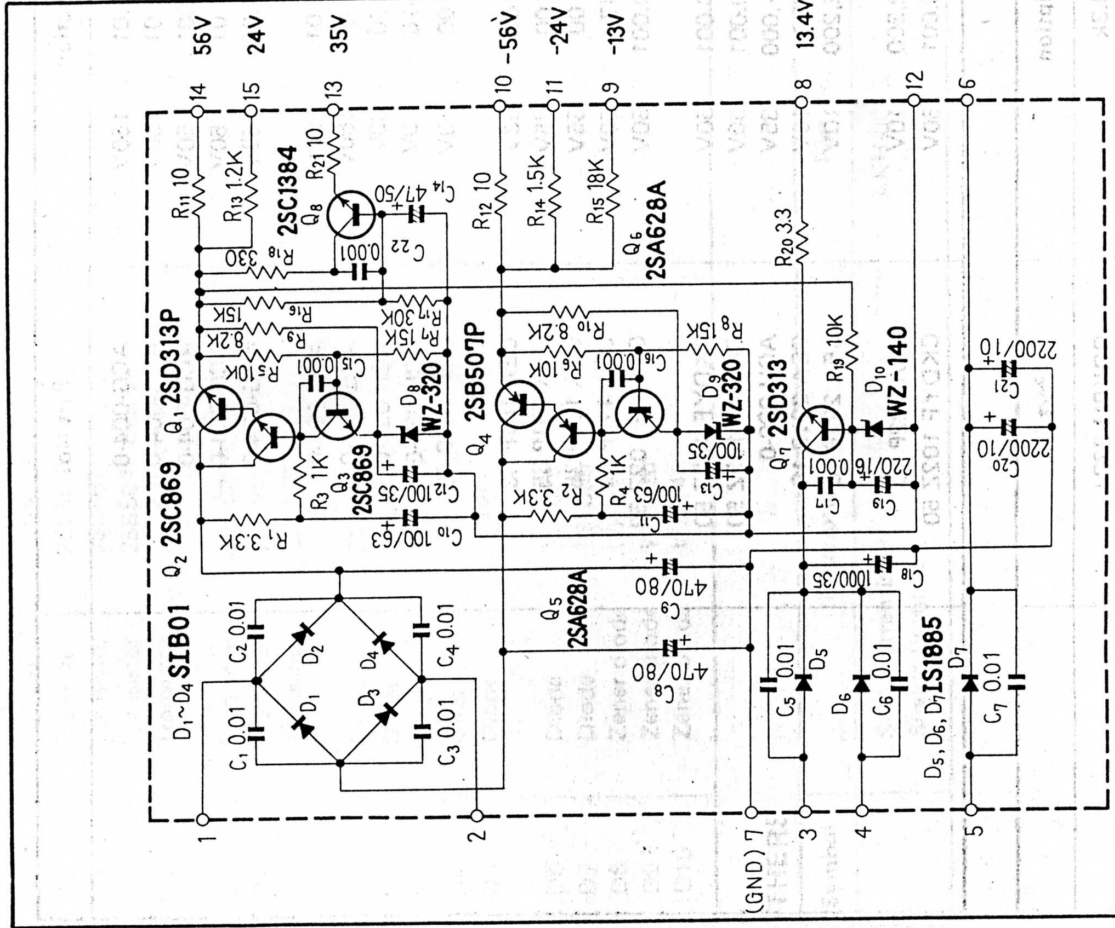

RESISTORS
 2SD313P
 2SD313
 2SB507P
 2SC869
 2SC1384
 2SA628A

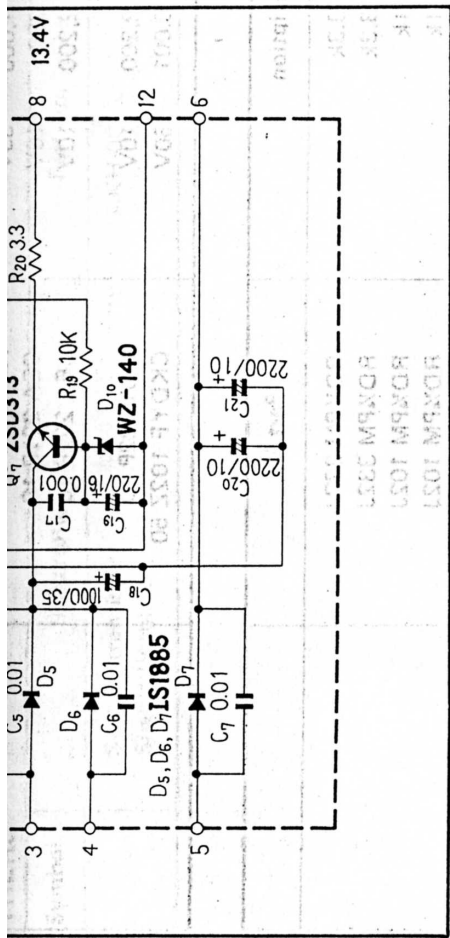

Foil Side

